

Centerfire™ Consumable Series

Issued Feb. 2017 • Index No. CFC/1.1

MIG (GMAW) Welding Consumables 

Quick Specs	Applications	System Components	Compatible With	Wire Sizes
	Shipbuilding Trailer Fabrication Heavy Equipment Manufacturing	Contact Tips Nozzles Diffusers / Tip Holders Insulators	BTB Series MIG Guns NEW! Clean Air Series Dura-Flux™ Fixed Liner Series FILTAIR™ Fume Extraction Series Legacy Q-Gun™ and S-Gun™ Series	0.023" to 1/8" (0.06 to 3.2 mm)

Centerfire™ Series Consumables

are easy-to-use and high performing. Developed with the user's cost consideration in mind, Centerfire Series Consumables provide better arc starts, less spatter and more consistent welds, while lasting up to three times longer than most brands.

Threaded nozzle keeps contact tip centered for better weld placement and less spatter. Holds tips fixed at 1/4" or 1/8" recess, flush, or 1/8" stick out.

Composite insulator extends life and withstands heat abuse.

Centerfire Nozzles have a built-in spatter shield that smooths and concentrates gas glow for less weld oxidation and contamination.

Centerfire Contact Tips have a tapered base to improve conductivity.

Diffuser mates securely with contact tip for better conductivity.

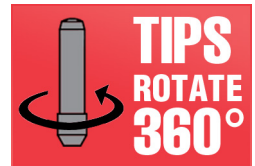
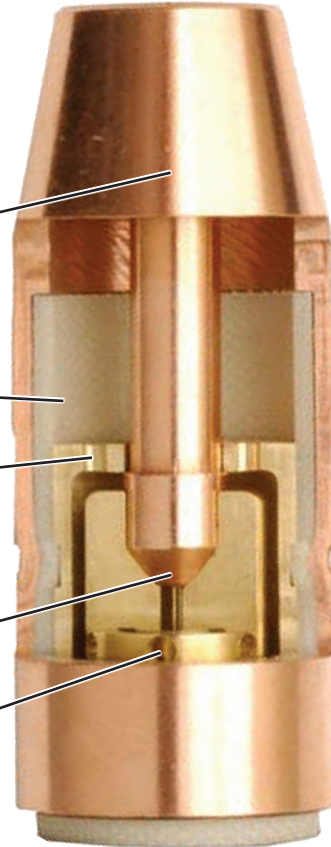

Rotate to create new wear surfaces and extend tip life



No tools needed to change nozzles and contact tips



Better arc starts, less spatter, more consistent welds

Centerfire HD Consumables

are designed for shipbuilding, trailer fabrication and other heavy manufacturing operations. These heavy-duty nozzles feature an easily removable and replaceable nozzle cone (the most frequently damaged part of the nozzle), thicker walls and a new, high temperature insulator.



Bernard

A Division of Miller Electric Mfg. Co.
449 West Corning Road, Box 667
Beecher, Illinois 60401 USA

Phone: 1-855-MIGWELD (644-9353) (US & Canada Only)
+1-519-737-3000 (International)

Fax: 708-946-6726

For more information, visit us at BernardWelds.com

Centerfire Series

Small Centerfire™ Gas Diffusers and Nozzles

Available Parts

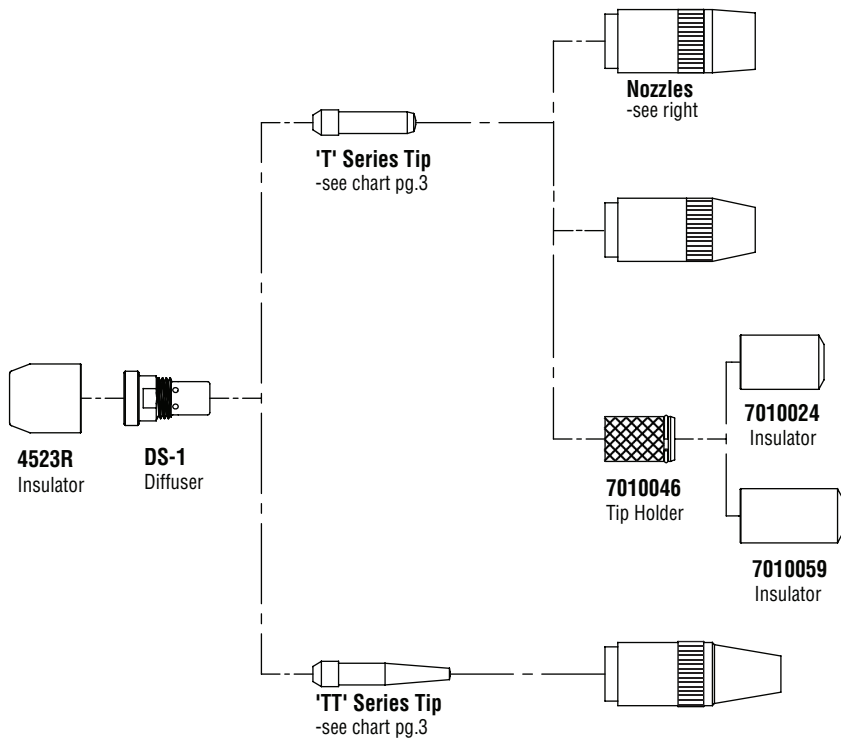

Nozzles

- NS-5800C** 5/8" Bore, Flush, .875" O.D., Copper
- NS-5818C** 5/8" Bore, 1/8" Recess, .875" O.D., Copper
- NS-5800B** 5/8" Bore, Flush, .875" O.D., Brass
- NS-5818B** 5/8" Bore, 1/8" Recess, .875" O.D., Brass

- NS-1218C** 1/2" Bore, 1/8" Recess, .875" O.D., Copper
- NS-1200B** 1/2" Bore, Flush, .875" O.D., Brass
- NS-1218B** 1/2" Bore, 1/8" Recess, .875" O.D., Brass

NS-FLX Self-Shielded Conversion Kit
(Includes tip holder and both insulators)

- NST-3800B** 3/8" Bore, Flush, .875" O.D., Brass
- NST-3818B** 3/8" Bore, 1/8" Recess, .875" O.D., Brass
- NST-38XTB** 3/8" Bore, 1/8" Extension, .875" O.D., Brass

Large Centerfire™ Gas Diffusers and Nozzles

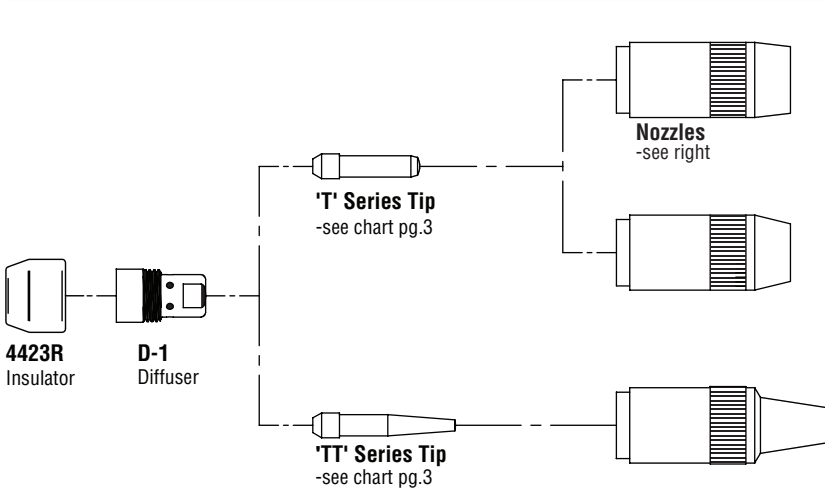

- N-3400C** 3/4" Bore, Flush, 1.063" O.D., Copper
- N-3418C** 3/4" Bore, 1/8" Recess, 1.063" O.D., Copper
- N-3414C** 3/4" Bore, 1/4" Recess, 1.063" O.D., Copper
- N-3418B** 3/4" Bore, 1/8" Recess, 1.063" O.D., Brass
- N-3414B** 3/4" Bore, 1/4" Recess, 1.063" O.D., Brass

- N-5800C** 5/8" Bore, Flush, 1.063" O.D., Copper
- N-5818C** 5/8" Bore, 1/8" Recess, 1.063" O.D., Copper
- N-5814C** 5/8" Bore, 1/4" Recess, 1.063" O.D., Copper
- N-5818B** 5/8" Bore, 1/8" Recess, 1.063" O.D., Brass
- N-5814B** 5/8" Bore, 1/4" Recess, 1.063" O.D., Brass

- NT-3800C** 3/8" Bore, Flush, 1.063" O.D., Copper

Diffusers, nozzles and contact tips are available in packages of 10 and insulators are available in packages of 5

Water-Cooled Centerfire™ Gas Diffusers and Nozzles

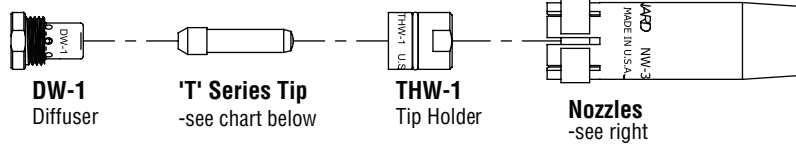

Nozzles

- NW-3418C** 3/4" Bore, 1/8" Recess, 1.000" O.D., Copper
- NW-3414C** 3/4" Bore, 1/4" Recess, 1.000" O.D., Copper

Centerfire™ HD Gas Diffusers and Nozzles

Available Parts

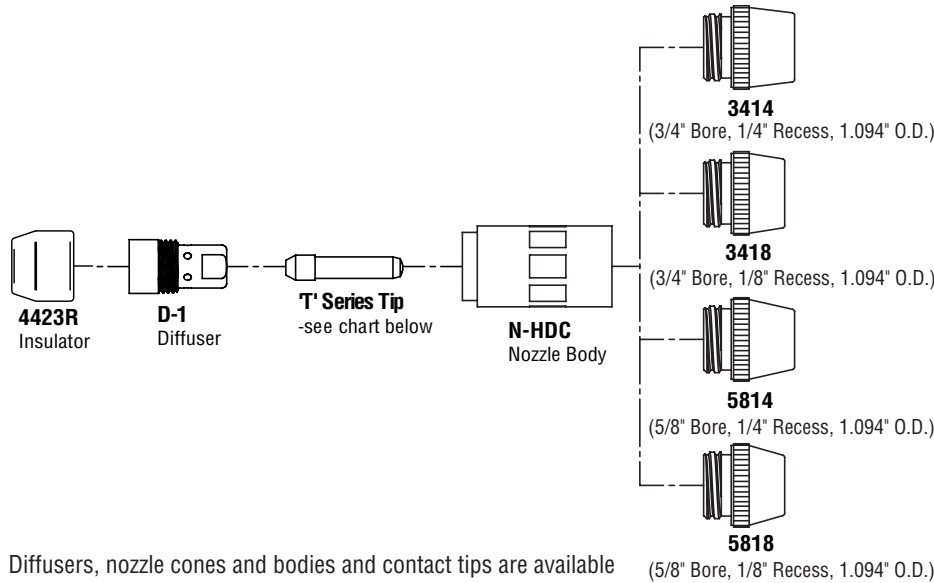

Details

- Couple the Centerfire HD Nozzle Body (**N-HDC**) with a Centerfire HD Nozzle Cone to form a complete Centerfire HD Nozzle.
- One nozzle body and one nozzle cone required, order separately.
- Use Centerfire HD Nozzles with standard Centerfire **4423R** Insulator Caps, **D-1** Gas Diffusers and **'T'** Series Contact Tips.

Centerfire HD Consumable Series Installation

1. Install insulator over neck.
2. Trim liner as per the directions below.
3. Torque diffuser onto neck to approx. 12ft-lbs.
4. Insert contact tip into diffuser.
5. Thread nozzle body onto diffuser / contact tip and tighten firmly by hand.
6. Thread nozzle cone onto nozzle body and tighten firmly by hand.

Diffusers, nozzle cones and bodies and contact tips are available in packages of 10 and insulators are available in packages of 5

Centerfire Contact Tips

'T' Series Contact Tips (0.350" O.D.)

T-023	0.023"	(0.6 mm)
T-030	0.030"	(0.8 mm)
T-035	0.035"	(0.9 mm)
T-039	0.039"	(1.0 mm)
T-045	0.045"	(1.2 mm)
T-052	0.052"	(1.4 mm)
T-062	1/16"	(1.6 mm)
T-072	0.072"	(1.8 mm)
T-078	5/64"	(2.0 mm)
T-094	3/32"	(2.4 mm)
T-109	7/64"	(2.8 mm)
T-125	1/8"	(3.2 mm)

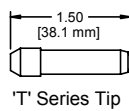

'TT' Series Contact Tips (0.350" O.D.)

TT-023	0.023"	(0.6 mm)
TT-030	0.030"	(0.8 mm)
TT-035	0.035"	(0.9 mm)
TT-039	0.039"	(1.0 mm)
TT-045	0.045"	(1.2 mm)
TT-052	0.052"	(1.4 mm)
TT-062	1/16"	(1.6 mm)

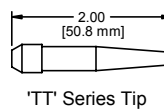

Aluminum Specific Contact Tips (0.350" O.D.)

T-035AL	0.035"	(0.9 mm)
T-047AL	3/64"	(1.2 mm)
T-062AL	1/16"	(1.6 mm)

Standard Installation

1. Install insulator over neck.
2. Trim liner as per the directions below.
3. Torque diffuser onto neck to approx. 12ft-lbs.
4. Insert contact tip into diffuser.
5. Thread nozzle onto diffuser / contact tip and tighten firmly by hand.

Available in packages of 10 contacts tips.

Liner Trim Guidelines

To know the optimal length to trim your liner simply find your diffuser part number from the list below and trim to the corresponding length.

- | | |
|-----------------------------|--------------------------------|
| D-1 9/16" (14.3 mm) | D-1T 13/16" (20.6 mm) |
| DS-1 9/16" (14.3 mm) | D-1T-5 13/16" (20.6 mm) |
| DW-1 1/4" (6.4 mm) | DS-1T 5/8" (15.9 mm) |

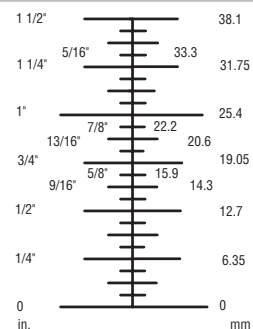

Centerfire™ Conversion Series

Simplify parts management and improve performance by converting all of your MIG guns to Centerfire Contact Tips, Nozzles and Diffusers. Find your MIG gun make and model on the left, then follow the chart to the right for parts needed to upgrade.

Conversion Installation

1. Install conversion adapter (if required).
2. Install insulator cap over conversion adapter.
3. Proceed with Standard or Centerfire HD Series installation.

Gun Manufacturer	Gun Model	Desired Nozzle / Diffuser Style	Adapter	Insulator	Diffuser	Contact Tip	Nozzle
Bernard™	Q-Gun™, EZ Feed II, H, F	Small	Not Required	4323R	DS-1	Select from tips on page 3	Select from nozzles on pages 2-3 <i>Note: use small nozzles with small diffusers and large nozzles with large diffusers</i>
		Large	Not Required	10012	D-1		
Binzel®	ALPHA 2, ALPHA 2 Automatic	Small	Not Required	4323R	DS-1B2		
		Large	N/A	N/A	N/A		
	ALPHA 3, ALPHA 3 Automatic	Small	Not Required	4323R	DS-1B3		
		Large	Not Required	4323R	D-1B3		
	ALPHA 4, ALPHA 4 Automatic	Small	N/A	N/A	N/A		
		Large	Not Required	4323R	D-1B4		
	OMEGA 4	Small	N/A	N/A	N/A		
		Large	Not Required	4323R	D-1B04		
Lincoln®	100L	Small	1380020	4323R	DS-1		
		Large	N/A	N/A	N/A		
	Magnum 250	Small	1380005	4323R	DS-1		
		Large	1380005	10012	D-1		
	Magnum 300, Magnum 400	Small	Not Required	4323R	DS-1T		
		Large	Not Required	4423R	D-1T		
	Magnum 500	Small	1380017	4323R	DS-1		
		Large	1380017	10012	D-1		
	Magnum Pro 300	Small	N/A	N/A	N/A		
		Large	Not Required	4323R	D-1LP3		
Miller®	XR Edge	Small	1380018	4323R	DS-1		
		Large	1380018	10012	D-1		
	XR30A, XR-W, Roughneck, Python	Small	Not Required	4323R	DS-1		
		Large	Not Required	10012	D-1		
	Aluma-Pro™	Small	Not Required	4323R	DS-1AP		
		Large	Not Required	10012	D-1AP		
OXO™	APX	Small	Not Required	4323R	DS-1		
		Large	Not Required	10012	D-1		
Tregaskiss™	Former TOUGH GUN™ Semi-Automatic Series or the former Bernard T-Gun™	Small	Not Required	4323R	DS-1T		
		Large	Not Required	4423R	D-1T		
Tweco®	160 Mini Mig	Small	1380020	4323R	DS-1		
		Large	1380020	10012	D-1		
	No. 1	Small	1380019	4323R	DS-1		
		Large	1380019	10012	D-1		
	No. 2	Small	1380005	4323R	DS-1		
		Large	1380005	10012	D-1		
	No. 3, No. 4, Tuff-n-Lite, Supra® XT (HD Consumables)	Small	Not Required	4323R	DS-1T		
		Large	Not Required	4423R	D-1T		
	Spraymaster® 450	Small	Not Required	4323R (2 Required)	DS-1T		
		Large	Not Required	4423R	D-1T		
	No. 5	Small	N/A	N/A	N/A		
		Large	Not Required	4423R	D-1T-5		
	ELC 250, ELC 350, Spraymaster® 250, Spraymaster® 350	Small	1380012	4323R	DS-1		
		Large	1380012	10012	D-1		
ELC 450, EL 450, EL 600, Supra® XT (EL Consumables)	Small	1380017	4323R	DS-1			
	Large	1380017	10012	D-1			

Centerfire™ Contact Tips, Nozzles, and Diffusers are manufactured by Bernard. Bernard™, Miller®, Tregaskiss™, Centerfire™, Q-Gun™ and T-Gun™ are trademarks of Illinois Tool Works, Inc. Other brands mentioned are for reference only and are the registered trademarks of their respective companies. Illinois Tool Works, Inc. is not affiliated with these other companies.

Subject to Change – The information presented in this spec sheet is accurate to the best of our knowledge at the time of printing. Please visit BernardWelds.com for the most up-to-date information.

Distributed By:

